

FRN *List Price*

Heavy Duty Cylindrical Leversets
ANSI - A156.2, Series 4000, Grade 2
FRN Series (Non-Clutch Mechanism)

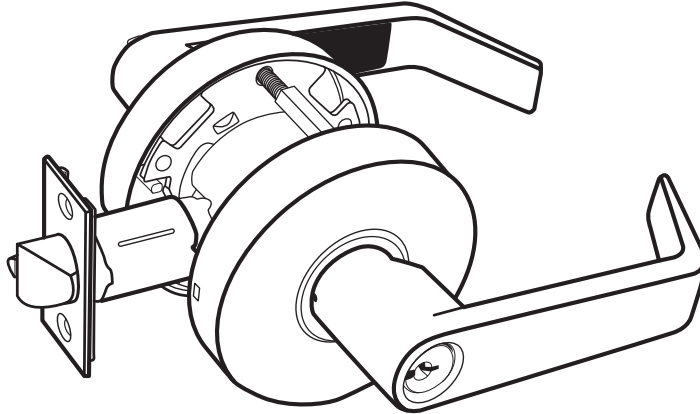

MEETS
The Buy American Act

**LIFETIME
WARRANTY**

STOCK ITEM PRICES IN BOLD
NON-STOCK FINISHES AND DESIGNS AVAILABLE WITH FACTORY LEAD TIME
AND SUBJECT TO MINIMUM ORDER.

FUNCTIONS	ANSI	ITEM #	US26D	PCS /MC
Entrance	F109	FRN00	\$80.56	10
Storeroom	F91	FRN05		
Classroom	F84	FRN03		
Privacy	F76	FRN20	66.78	
Passage	F75	FRN30	64.66	
Dummy	---	FRN40	23.32	

► **PACKAGING INCLUDES**

- UL Listed 2 3/4" Backset,
2 1/4" faceplate
- Standard "C", 6-pin cylinder
- ASA Strike

► **MOUNT**

2 hole wooden mount
Part# SLMOUNT
List: \$66.17







► **TACTILE AND LEAD LINING**

Lead Lining **Part # LEAD**
Add \$124.86 List
Tactile **Part# TAC Add \$25.44 list**

QUANTITY DISCOUNT
50 UNITS MIXED - LESS 5%
100 UNITS MIXED - LESS 10%

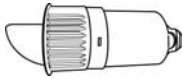
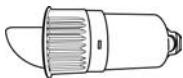
► **ADDITIONAL PARTS & CHARGES**

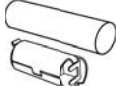
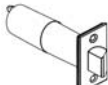
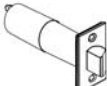
Backsets: UL listed 2 3/8", (2 1/4" x 1") faceplate, **NO EXTRA CHARGE** if ordered with lock only.
 Otherwise \$11.66 List Each.

◆◆ STANDARD DISCOUNT ONLY ◆◆				
ILLUSTRATION	ITEM #	DESCRIPTION	FINISH	LIST PRICE
	ULSLD238	SL Series UL-listed Dead Latch 2 3/8" 2 1/4" x 1" Faceplate	US3,26D,10B,10,26	\$11.91
	ULSLS238	SL Series UL-listed Spring Latch 2 3/8" 2 1/4" x 1" Faceplate	US26D,10B,10,26	
	SLDRI-1	2 3/4" Entrance, Drive-in Latch bolt for G2 Lockset	ZINC	
	SLDRI-2	2 3/4" Privacy/Passage, Drive-in Latch bolt for G2 Lockset		
	SLDRI-4	2 3/8" Entrance, Drive-in Latch bolt for G2 Lockset		
	SLDRI-5	2 3/8" Privacy/Passage, Drive-in Latch bolt for G2 Lockset		
EXTRA UL LISTED BACKSET				
	ULSLD234	SL Series Dead Latch 2 3/4" 2 1/4" x 1 1/8" Faceplate	US3,26D,10B,10,26	11.91
	ULSLS234	SL Series Spring Latch 2 3/4" 2 1/4" x 1 1/8" Faceplate	US3,26D,10B,10,26	
3 3/4", 5" UL LISTED BACKSET				
	SL5	5" UL listed Extension Link	----	17.21
	SLD334	3 3/4" Dead latch, 2 1/4" x 1 1/8" Faceplate	US3,26D,10B	
	SLS334	3 3/4" Spring Latch, 2 1/4" x 1 1/8" Faceplate	US3,26D,10B	
STRIKES				
	TS	T-Strike	US3,26D,10B, 10,26,15,4	2.12
	FLS	Full lip strike	US3,26D,10B, 10,26,15,4	